

PRODUKTBLATT

Abschließbarer Schaukasten Outdoor Slim 4 x A4 Anthrazit

SCTE4xA4PHC7016JS



- IP56 zertifiziert vollständig wetterfest
- Schlanke und elegante Optik
- Mit weißer magnetischer Rückwand
- Brandschutzzertifikat B1 nach DIN 4102

PRODUKTBLATT

Abschließbarer Schaukasten Outdoor Slim 4 x A4 Anthrazit

SCTE4xA4PHC7016JS

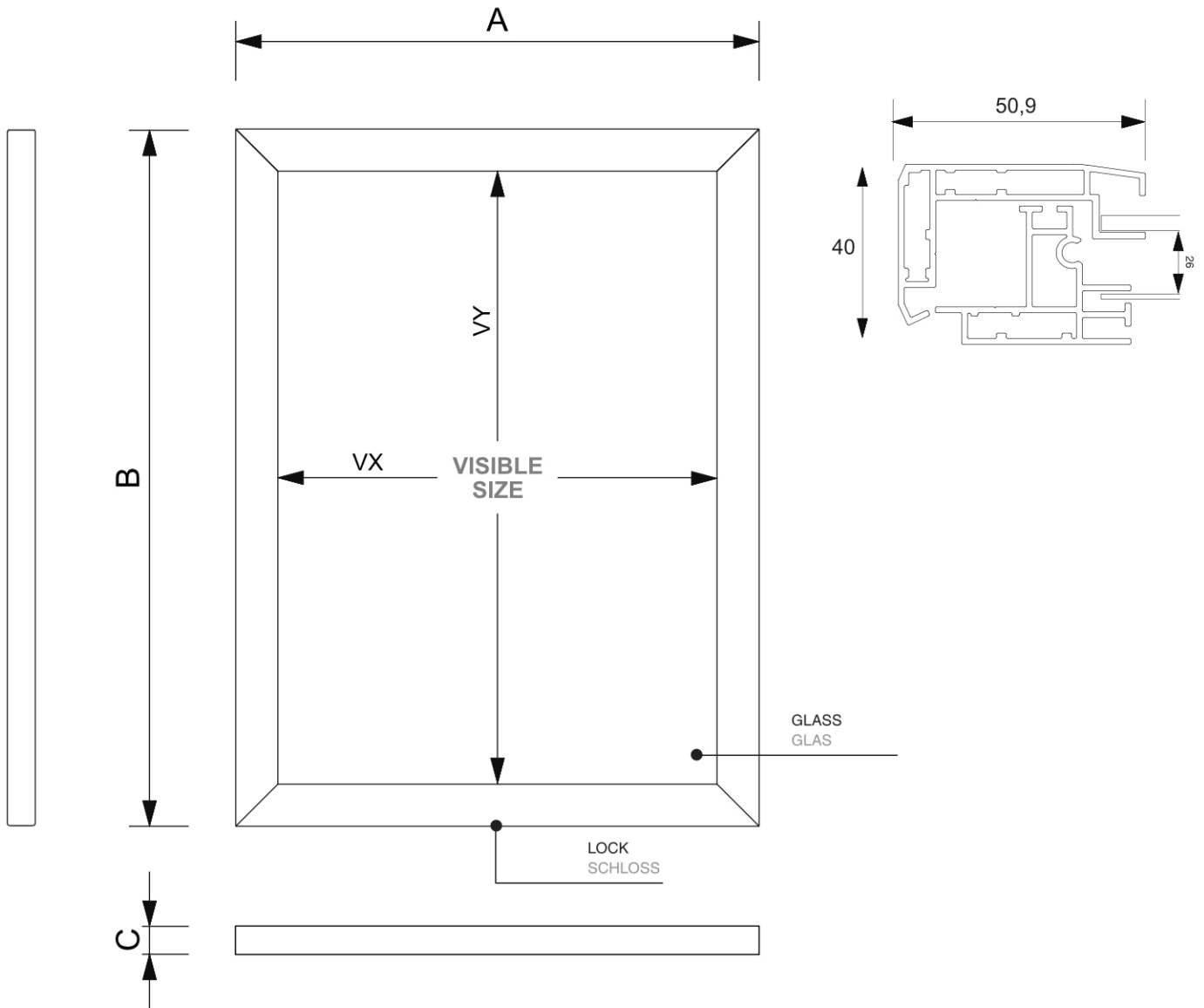

ACCESSORIES ZUBEHÖR

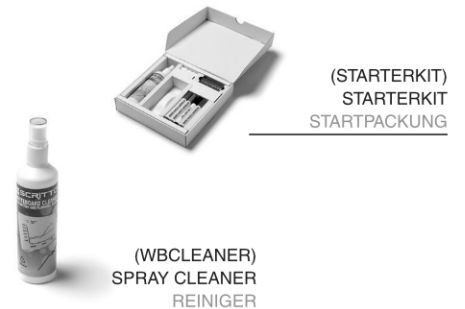

PRODUKTBLATT

Abschließbarer Schaukasten Outdoor Slim 4 x A4 Anthrazit

SCTE4xA4PHC7016JS

BASISINFORMATIONEN

SKU	Sizes (mm) (A x B x C)	Format (mm)	Sichtbare Größe (mm) (VXxVY)	Lochabstand (mm) (XxY)
SCTE4xA4PHC7016JS	530 x 705 x 40	4xA4	428 x 603 mm	-

Ausrichtung	Weight (kg)
Senkrecht	9,30

ELEKTRISCHE PARAMETER

Beleuchtung	Lichtfarbe (K)	Helligkeit (cd)	Lichtintensität (lx)	Leistung (W)
Nein	-	-	-	-

VERPACKUNGSGINFORMATIONEN

Verpackungseinheit 1 (mm)	Verpackungseinheit 2 (mm)	Verpackungseinheit 3 (mm)
770 x 600 x 110	-	-

Palette Stückzahl	Palettengewicht (kg)	Palettenart
36	392	EUR

MEHR INFORMATIONEN

Produktzertifizierung	EAN
IP56, DIN4102B1	8596052174865